



GEREX

2711 TOLEDO STREET #505, TORRANCE, CA 90503 213/328-1918

INSTALLING MULTIFIRE ON HONDA "FOURS"

MULTIFIRE is the finest, most advanced ignition system available for your Honda. You'll experience that "just tuned" performance for thousands of miles without ignition maintenance of any sort. You'll have more time to ride and enjoy riding more.

Save time, Avoid errors. Read these instructions BEFORE starting installation.

It helps to have all tools available before disabling your transportation. Don't forget Loctite, grease, plugs, etc.

MULTIFIRE is really very easy to install, but errors can cause substandard performance, or worse, damage to the system. Follow instructions carefully, then check your work.

If you are installing a MULTIFIRE on a "400", it will be necessary to replace your advancer unit with a "750" advancer.

Remove the fuel tank, right side trim panel and point plate cover. If you are installing a rear mount system, taking the seat and left side trim panel off is not mandatory, but it sure makes the installation easier.

POINT PLATE

Take off the point plate by removing the three Phillips head screws. Trace the point plate cable up to where it joins the main wire harness. Disconnect the YELLOW and BLUE terminals and remove the cable (note how it is routed as you will re-route the new cable in the same manner). Using a sharp knife, cut the rubber grommet from the old points cable as shown. Replace it on the MULTIFIRE sensor cable.

Remove the screw clamping the wires to the point plate. Mount the clamp on the new sensor plate, using the screw provided.

Saw a slot in the engine case to cable hole, so that new cable can be slipped thru. Deburr new slot.

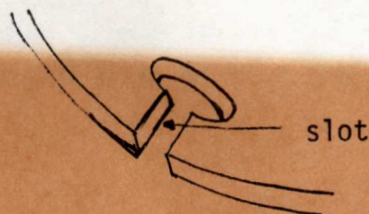

AUTOMATIC ADVANCER

FIGURE 1. (Where did I leave the damned spring clip?)

Remove automatic advance unit by unscrewing bolt at end of point cam.

Clean housing thoroughly.

Remove spring clips (2A), spring washers (2B), and flyweights, (2C) from pivot studs. Disconnect springs (2D). Remove and discard cam (2E). Remove large steel washer (2F) from center shaft. Clean all parts of advancer unit thoroughly (but don't lose them).

To reassemble, place one washer (2B) on each pivot stud and one large steel washer (2F) on the center shaft. Connect springs (2D) to flyweights (2C) and replace this assembly on pivot studs. Replace remaining washers (2B) and spring clips (2A).

Wipe a thin film of light grease on advance shaft. DO NOT USE LUBRIPLATE!

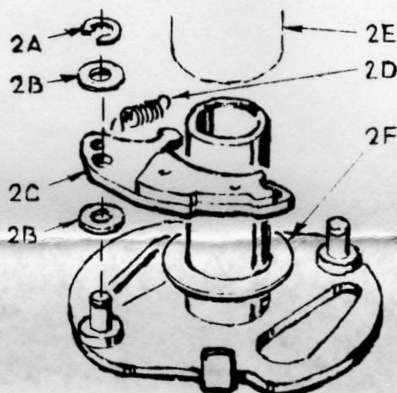

Figure 1. GL-1000 shown

ADVANCER-ROTOR

Remove and discard magnet keeper (small disc on magnet).

Slide the MULTIFIRE rotor on the shaft (small end first). The flyweights must be pulled away from the shaft and the rotor twisted into proper position before the rotor will slide all the way onto the shaft. DO NOT FORCE! The rotor can be installed on the advancer unit in two positions. Looking at the advance unit with the 1-4 markings in the 12 o'clock position, the magnet of the rotor MUST be at the 9:30 position.

Turn the rotor into full advance position against the springs. Make sure the rotor turns smoothly on the shaft and snaps back to the retard position.

Replace the automatic advance unit on the crankshaft. Be certain the unit engages the crankshaft key properly. Replace and tighten the large nut and small bolt.

SENSOR PLATE

Turn the engine over so that the magnet and brass weight are in vertical alignment.

Slide the sensor plate over the rotor and position it in the housing. When the plate sits firmly in the housing, secure it with the Phillips head screws from the old point plate. Clamp the wires on the plate so that they are routed around the outside of the sensor plate to avoid the rotor.

Route the cable as before up the frame to the center of the bike. If you have a rear mount, run the cable up and across near the top of the battery.

VERY CAREFULLY AND VERY SLOWLY, using the kick starter, turn the engine over and watch carefully as the rotor approaches the sensor, the small chip sticking out of the sensor must pass through the center of the magnet. (See Figure 2).

If it clears, continue around to the next sensor and repeat procedure. Also, check the brass weight as it passes each sensor. Small adjustment in height can be made by adding or removing the thin washers that are under the rotor on the advancer shaft.

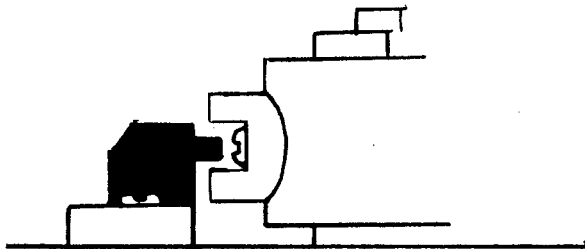

Figure 2.

C-D MOUNT - REAR

The rear mount system is mounted on the bolt that goes through the tail light bracket and frame into the fender, on the right side of the bike (See Figure 3).

Remove the bolt holding the tail light bracket to the frame. Slip the mounting bracket between the frame and fender. Replace the tail light bracket and bolt.

Slip the wires through the 3/4" hole in the mounting plate. (It's easier if you put the plastic connector through the hole first, then the rest of the wires). Take the wires straight up to the frame (use a big screwdriver to separate the fender and frame) and feed them forward on top of the fender, around the battery. The two BLACK wires will go to the battery. The twisted wires with the plastic connector should meet the sensor plate cable near the battery. The rest of the wires in the sleeving will go up the frame center tube to the coils.

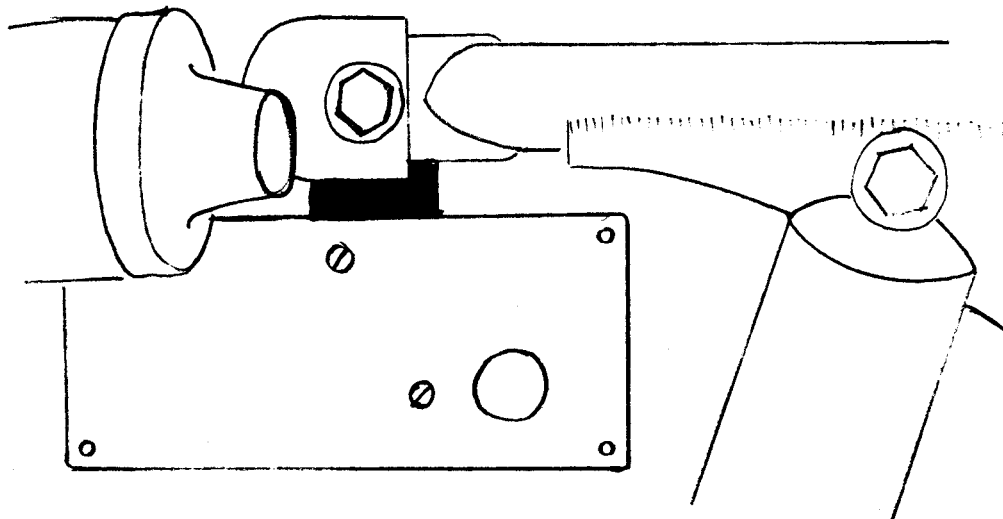

CHANGES IN MOUNTING PROCEDURES

The Series II GEREX is smaller and different in configuration. The cable no longer comes out the back, but exits at the end cap. The harness no longer goes thru a hole in the mounting plate. Rubber grommets are no longer used. The C-D unit is secured to the mounting plate with four socket head screws. Place the very thin washer on the screw then place it in the mounting hole in the ABS end cap. Besure the washer is used to keep the screw from gouging the plastic. Use LOCKTITE on all nuts

Tie the cable up to the frame as it comes out of the C-D unit, as close to the mounting plate and as far away from the tire as possible.

Secure the C-D unit to the mounting plate using the screws and washers provided. Use Blue Loctite on all screws. Tighten the screws just to the point where the washers will not rotate, if you go any farther, you will crush the grommets. The Loctite will hold the screws securely.

CONNECTING THE WIRES

FIGURE 4. (I'll bet I can plug it together backwards).

Connect C-D cable (6A) to the sensor cable plug (6E). Note that one end of the connector is pointed and the other square so the connector can only be plugged in one direction.

Remove the negative bolt from the battery. Both BLACK ground wires MUST go on the negative (-) terminal of the battery. DO NOT ATTACH TO ANY POINT ON THE FRAME. The system will not operate properly unless the ground is to the battery. Secure the lug to negative bolt.

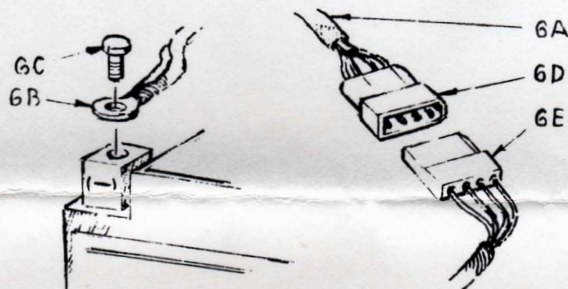
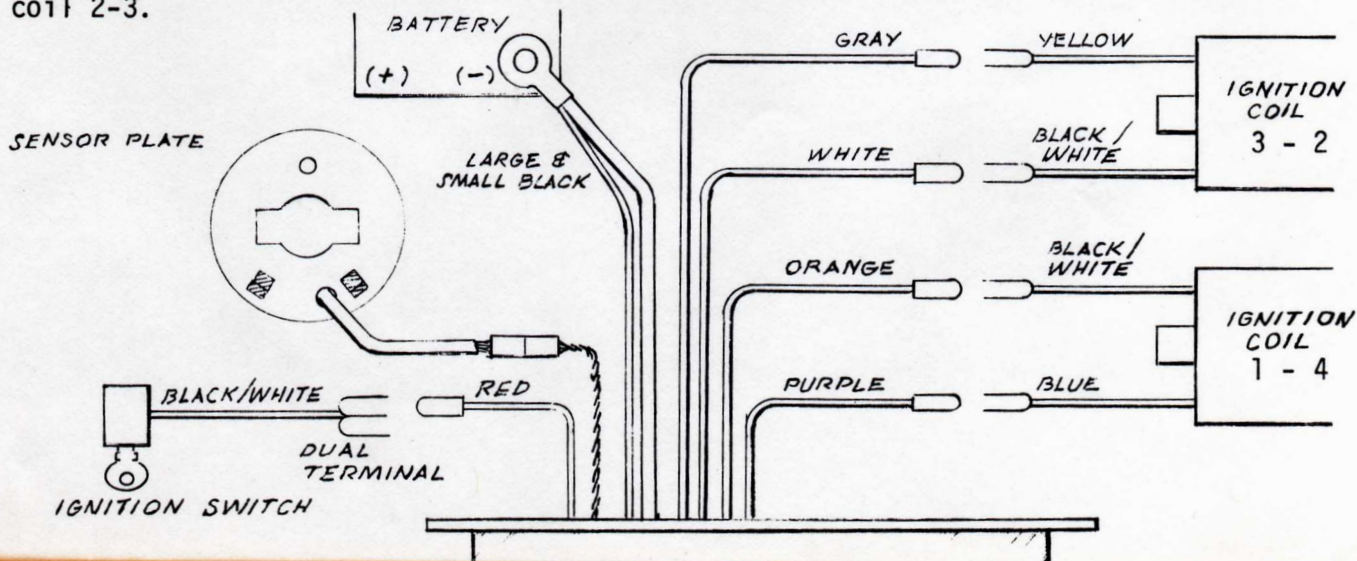

Figure 4.

COIL CONNECTIONS

FIGURE 5. (It would be white if you'd quit stepping on it).

Disconnect the two black/white coil wires from the dual female connector. Connect the red wire from the MULTIFIRE to either side of the dual female connector. Determine which coil fires cylinders 1 and 4 by following the high tension leads. To the black/white wire of coil 1-4, connect the orange MULTIFIRE wire (#16). The purple wire connects to the other 1-4 coil wire. Connect the white MULTIFIRE wire to the black/white wire of coil 2-3. The grey wire connects to the other wire of coil 2-3.



TIMING ADJUSTMENTMETHOD 1.

All 1977 and later model MULTIFIRE systems may be timed very accurately without operating the engine. Proceed as follows:

1. Remove spark plugs.
2. Reconnect plug wires to plugs and rest plug body against some portion of the machine.
3. Turn ignition switch on.
4. Using a wrench on the end of the crankshaft, rotate the engine clockwise very slowly until the rotor magnet approaches the sensor nearest the rear of the bike (1-4 sensor). Viewing the timing marks through the opening in the sensor plate, continue to rotate engine until the 1-4 cylinder spark plugs can be heard to fire.
5. Note position of the 1-4 cylinder "F" mark. If the mark has passed the reference timing mark when the 1-4 plugs fire, move the 1-4 (rear) sensor counter clockwise (against crank rotation) until plugs fire exactly on "F" mark.

Repeat procedure for 2-3 (front) sensor.

METHOD 2.

All MULTIFIRE systems may be timed with a high quality strobe light. If the light is battery powered, it must be connected to a battery other than the one in the machine under test. This is important.

1. Proceed as you would with points. Move 1-4 (rear) and 2-3 (front) sensors until timing is correct.

IMPORTANT

When timing is correctly adjusted for both sensors, snug the sensor retaining screws. Do not over tighten.

Place a small amount of silicone rubber cement at the head of each sensor mounting screw and at each end of the sensor. This will hold the sensors properly positioned and keep the screws from loosening.

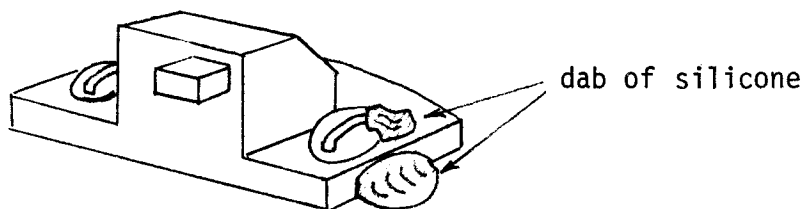

Figure 6.

This completes the installation.

PLUGS

FIGURE 7. (Can't now honey, I have to test the bike!)

Spark plugs should be replaced at this time. Re-gap plugs to .063" - .065".

Important, bend spark bar as shown (10B).

This is best done by straightening bar with a gapping tool (7F) and then rebending as shown (7D).

Many brands and types of plugs have been tested in all engines for which MULTIFIRE is available. In almost every case, the plugs recommended by the bike manufacturer have proven best. Gold palladium plugs offer no real advantage with MULTIFIRE.

Surface gap plugs are not recommended unless specified by the engine manufacturer.

A LAST WARNING: Don't attempt to draw a long spark from spark plug. MULTIFIRE won't mind, but your ignition coil may be destroyed.

AND ANOTHER: If a fairing is installed, be damned sure that a free blast of air passes over the C-D unit just as it does over the engine. Close all consoles, secure all covers. Wipe surplus Loctite off the seat and try to account for any pieces that may be left over.

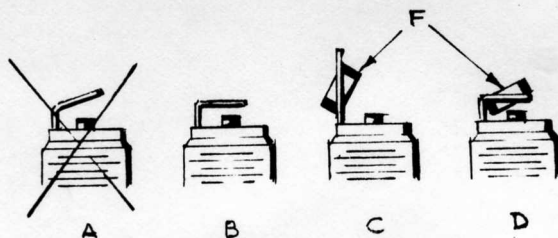

Figure 7.

AND ANOTHER: Make absolutely certain that the connections to the battery are as directed. If these wires are reversed, you will instantly ruin the electronics package. This type of damage will not be covered under warranty.

OEM PARTS & ACCESSORIES

Click on links below

[Honda SOHC4 OEM Parts & Online Schematics](#)

[Honda Cruiser Parts & Accessories](#)

[Honda Motorcycle Parts & Accessories](#)

[Save Up to 45% on Motorcycle Tires](#)

[Motorcycle Gear Closeout Sale](#)

[Cycle Gear Free Shipping](#)

[Honda CB550 Chain & Sprocket Kit](#)

[Honda CB550 CB500 Fork Boot Gaiter Set](#)

[Honda CB550 CB500 Left Sidecover](#)

[Honda CB550 CB500 Right Sidecover](#)

[Honda CB500 Piston Ring Set](#)

[Honda CB550 CB500 New Rear Shock Absorber](#)

*Classic Cycles
Technical Resources*

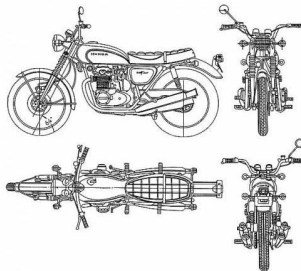

www.ClassicCycles.org

[Honda CB750 CB 750 Clutch Rebuild Kit](#)

[Honda CB750 CB 750 Complete Engine Gasket Set](#)

[Honda CB750 CB 750 Intake & Exhaust Valve Set K0 - K5 1969 to 1975](#)

[Honda CB750 CB 750 Engine Oil Seal Set K0 - K4 1969 to 1974](#)

[Honda CB750 CB 750 Frame Bolt Set](#)

[Honda CB750 CB 750 Front Fork Boot Gaiter Set](#)

[Honda CB750 CB 750 Fuel Gas Tank New Bare](#)

[Honda CB750 CB 750 Fuel Gas Tank New Painted Original OEM Colors](#)

[Honda CB750 CB550 CB500 CB 750 550 500 Fuel Petcock](#)

[Honda CB750 CB550 CB500 CB 750 550 500 Headlight Bucket Case](#)

[Honda CB750 CB 750 Ignition Points Plate Set Assembly](#)

[Honda CB750 CB 750 Piston](#)

[Honda CB750 CB 750 Piston Ring Set](#)

[Honda CB750 CB 750 Side Cover Left](#)

[Honda CB750 CB 750 Side Cover Right](#)

[Honda CB750 CB550 CB500 CB 750 550 500 Frame Bolt Set](#)

[Honda CB750 CB550 CB500 CB 750 550 500 Fuel Petcock Replacement](#)

[Honda CB750 CB550 CB500 CB 750 550 500 Headlight Bucket Case](#)

[Honda CB750 Four CB 750 Shock Absorber Set Rear](#)

[Honda CB750 CB550 CB500 CB 750 550 750 Tire Front 3.25 x 19 Period Correct](#)

[Honda CB750 CB550 CB500 CB 750 550 750 Tire Rear 4.00 x 18 Period Correct](#)

